

Ü-TOPIC

RECHARGEABLE MOTOR CYLINDER



TABLE OF CONTENTS

1	ÜTopic product description	2
2	Scope of delivery	3
3	Compatible accessories	3
4	Installation instruction	4
4.1	Preperation	4
4.2	Mounting the ÜTopic	6
4.3	Downloading the ÜTopic app	7
4.4	Important notes before installation	7
4.5	Startup via app	10
4.6	General app settings.....	13
4.7	Delayed locking via app	14
4.8	Automatic locking via app	15
4.9	Advanced app settings	15
4.10	User settings	17
4.11	Adding another permanent user	17
4.12	Unlocking the door via generated code	20
4.13	Pairing ÜTopic with compatible accessories	21
4.14	Delete user	23
4.15	Delete administrator	23
4.16	Report	24
4.17	Recharge	24
4.18	Softwareupdate	25
5	FAQ	26

Ü-TOPIC

RECHARGEABLE MOTOR CYLINDER



1. PRODUCT DESCRIPTION ÜTOPIC

ÜTopic is a retrofit motor for mechanical locking cylinders, which can be controlled via a free app. It enables the motorized opening and closing of the door. The automatic control takes place either by means of wireless keypad, fingerprint reader with integrated keypad, radio handheld transmitter or with your own smartphone (bluetooth).

The APP (Android & IOS) must be installed on the respective smartphone during commissioning. Additional authorizations can be generated and managed, which can be sent to other users by means of a code, among other things. Time-defined authorizations can also be easily set via the app: this allows, for example, automatic locking at certain times, access authorization for a limited period of time.

ÜTopic provides more safety and comfort in the living area with its simple operation, slim design and rechargeable battery. There is no need to replace the battery, it only needs to be recharged every 60 to 90 days with a charging cable (micro USB interface).

ÜTopic can be used for all doors with cylinder lock and is perfect for retrofitting. It does not require any wiring of the door leaf. The existing cylinder does not need to be replaced, but can continue to be used. The key must be sawed off according to the template. It is important that the profile cylinder protrudes 2 mm. Alternatively, the profile cylinder can be replaced by a cylinder already prefabricated by Südm Metall, including 4 keys. In this case, there is no need to cut the key.

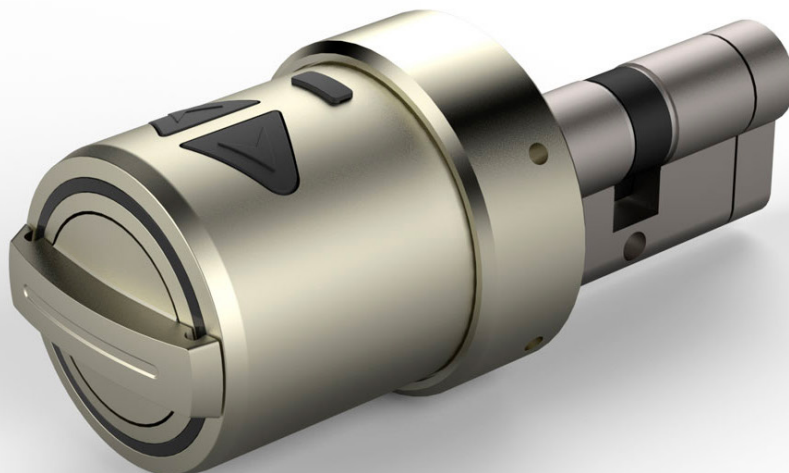

2. SCOPE OF DELIVERY

- 1 piece ÜTopic motor cylinder
- 1 piece micro USB charging cable
- 1 piece charging adapter
- 4 pieces mounting screws
- 1 piece allen key

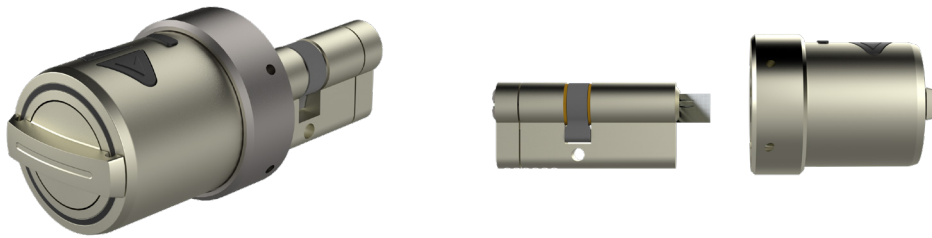

3. COMPATIBLE ACCESSORIES (NOT included in delivery!)

- Wireless keypad
- Fingerprintreader with integrated keypad
- Wireless remote control
- Design wireless remote control
- Smarthome Automation Interface (control of third-party systems)
- Auto locking module



4. INSTALLATION INSTRUCTIONS

4.1 PREPARATION

With the ÜTopic, both the existing cylinder and a cylinder from Südmetail purchased together with the ÜTopic can be used.

If you use the existing cylinder, the following preparatory work must be done first:

- Check if the existing cylinder protrudes at least 2 mm
- Saw off the key head using a vice etc. and then smooth the edges with a file (caution: Südmetail accepts no liability for damage!)
- Some keys may be thinner than 2.4 mm (about two euro coins thick). In this case, you may need to thicken the key with a few turns of tape after or before cutting

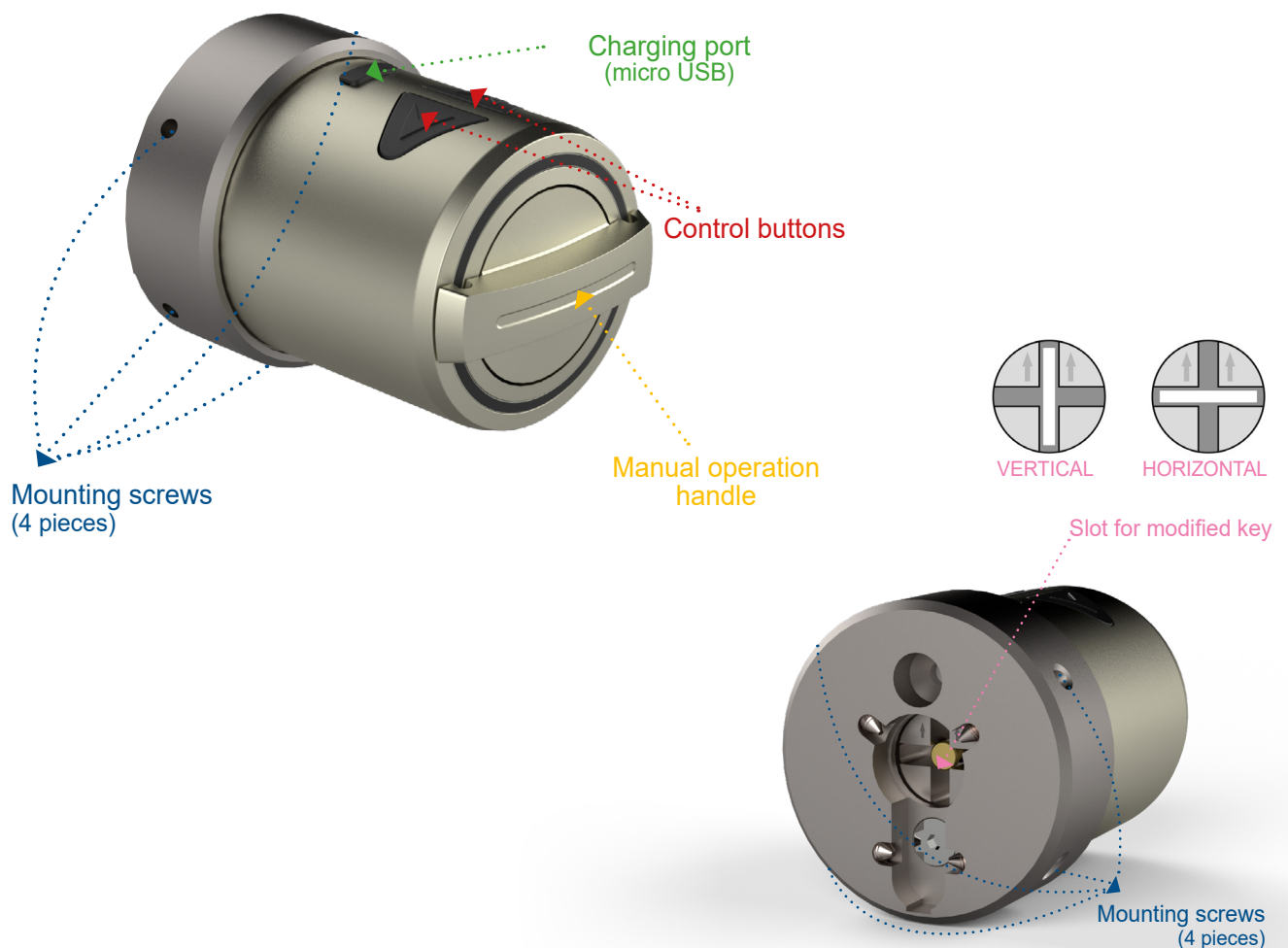

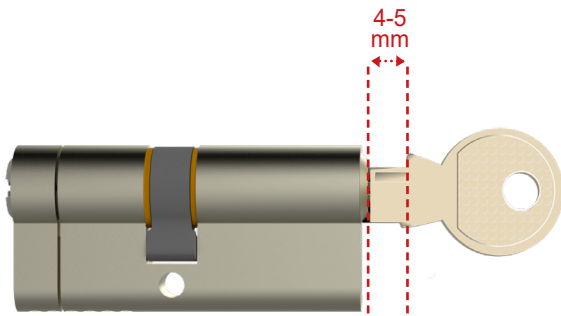

The key must be cut according to the template and protrude approximately 4-5 mm from the cylinder.

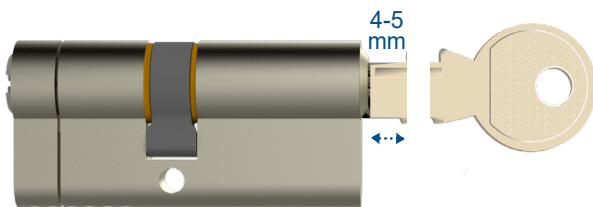

Cut off key, then lightly file off rough corners.

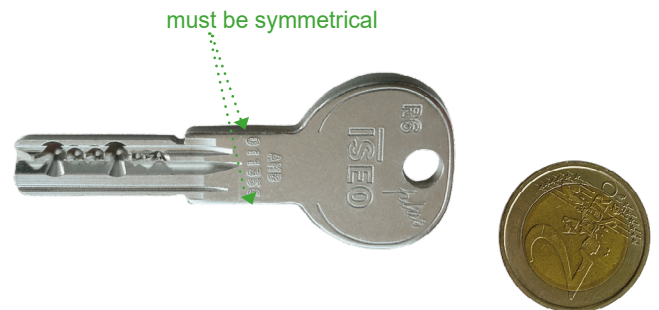
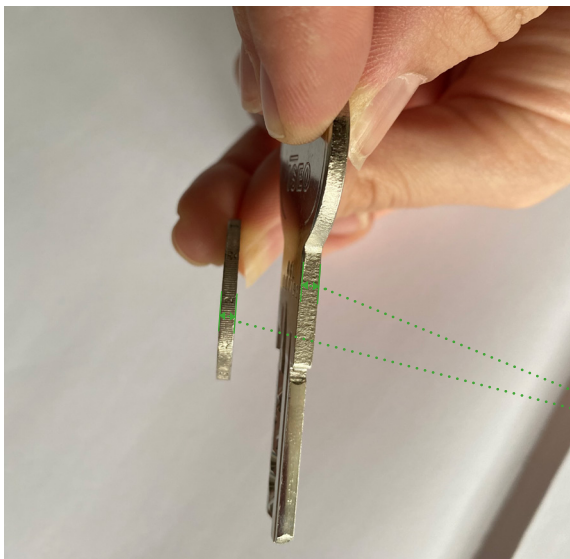

The thickness of the key should be at least 2.4 mm wide. If it is thinner, then wrap several times with adhesive tape until a thickness of approx. 2.4 mm is reached! A 2 euro coin has the ideal thickness - therefore it is best to use it as an aid.

4.2 MOUNTING THE ÜTOPIC MOTOR CYLINDER

- Insert the modified or sawed-off key into the cylinder
- Check the position of the motor cylinder - the arrows must point upwards
- Place the ÜTopic motor cylinder in the correct position and screw it to the inside of the door using the screws and allen key included in the scope of delivery

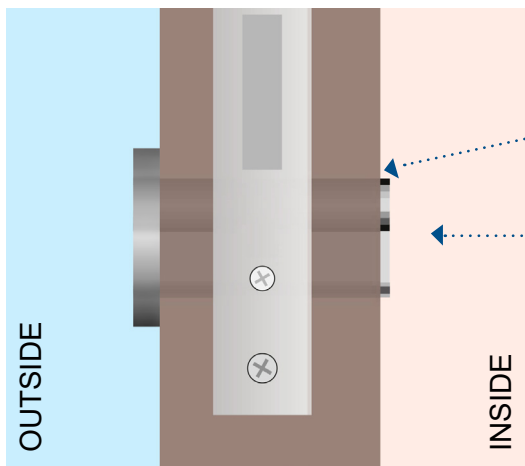

The ÜTOPIC is placed on the inside

The existing cylinder should protrude at least 2 mm to ensure the assembly!

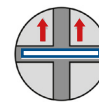
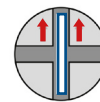
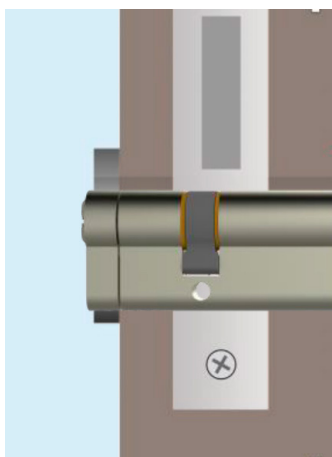

Arrows on the key slot must point upwards!

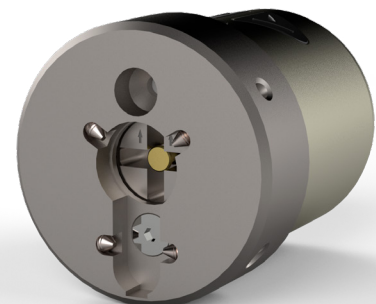

4.3 DOWNLOAD THE ÜTOPIC APP

- Download the free app (Android or IOS) via QR code on your smartphone:



ATTENTION!

Does not work with
Ipad or tablet!

4.4 IMPORTANT NOTES BEFORE INSTALLATION

- Please read the notes below (in the red bar) before you start the installation! Due to different operating systems, permissions must be granted without restrictions!

ATTENTION!

With Android you have to grant all permissions in the settings without restrictions (location, bluetooth,...)! In retrospect, this is no longer possible. Then you have to uninstall and reinstall the app again! Some Android smartphones may have problems when they are paired with the smartlock for the first time. These problems are due to the difference in Android versions. To solve this problem, simply follow the steps below.

For Android 10, you need to do the following:

1. Go to the settings of the Android device (Android 10)
2. Select „application manager“
3. Click on the 3 dots in the upper right corner and select all system apps
4. Select bluetooth from the large list of applications
5. Force stop
6. Select „Save“
7. Clear data and clear cache
8. Reboot smartphone



Android 10

ATTENTION!

For Android 11, you need to do the following:

1. Go to the settings of the Android device (Android 11)
2. Select the apps item in the drop-down menu
3. Next to „your apps“ activate the filter system
4. Activate the „show system apps“ field
5. Scroll down to the bluetooth item, then click on it
6. Click on the „storage“ item in the Bluetooth settings
7. At the very bottom, execute the two commands „Clear data“ and „Clear cache“
8. Reboot smartphone



Android 11

1. Go to the settings of the Android device (Android 11)

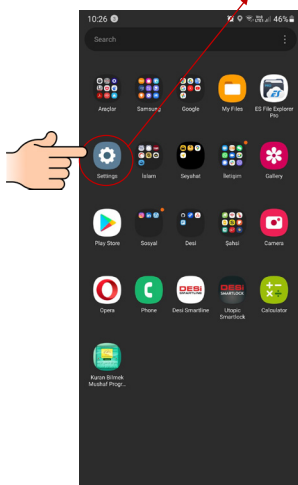

2. Select the apps item in the dropdown menu

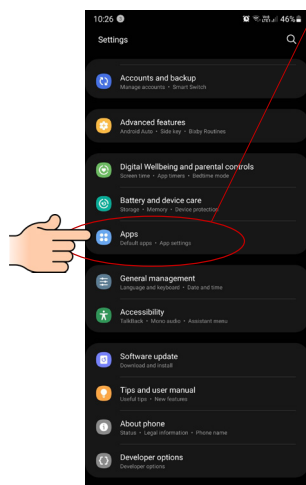

3. Next to „your apps“ activate the filter system

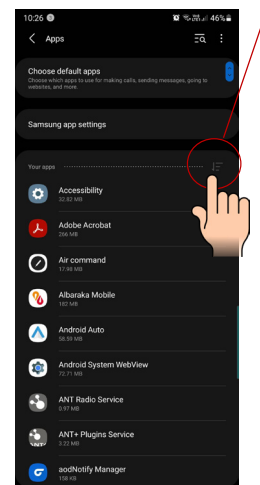

4. Activate the „show system apps“ field

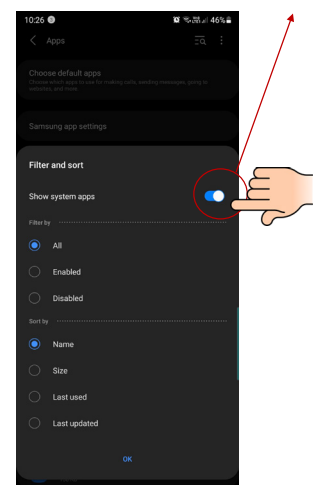

5. Scroll down to the bluetooth item, then click on it

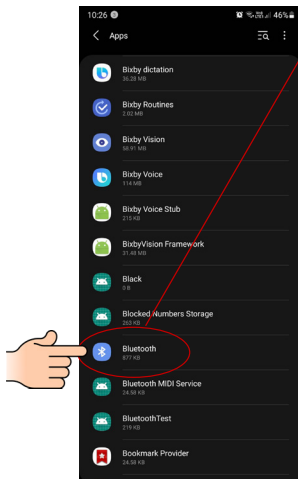

6. Click on the „storage“ item in the bluetooth settings

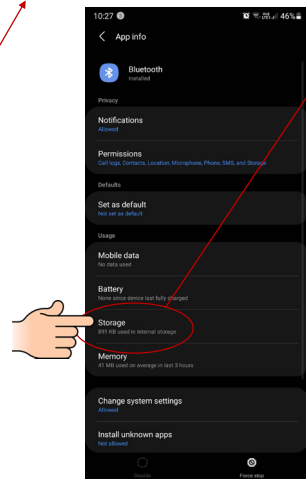

7. Execute the two commands „clear data“ and „clear cache“

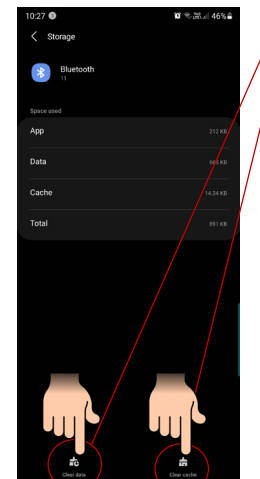

SETTINGS

ATTENTION!

For Android, please make sure that the location is really activated. Otherwise the app can not be installed correctly! To avoid this, please note the following:

1. Go to the settings of the Android device
2. Select the item location and move the slider on the top to the right to „ON“
3. To check if the location has actually been activated, select the item apps in the drop-down menu and then select ÜTopic
4. If the location is allowed in the app permissions of the ÜTopic smartlock app, then you have done everything correctly

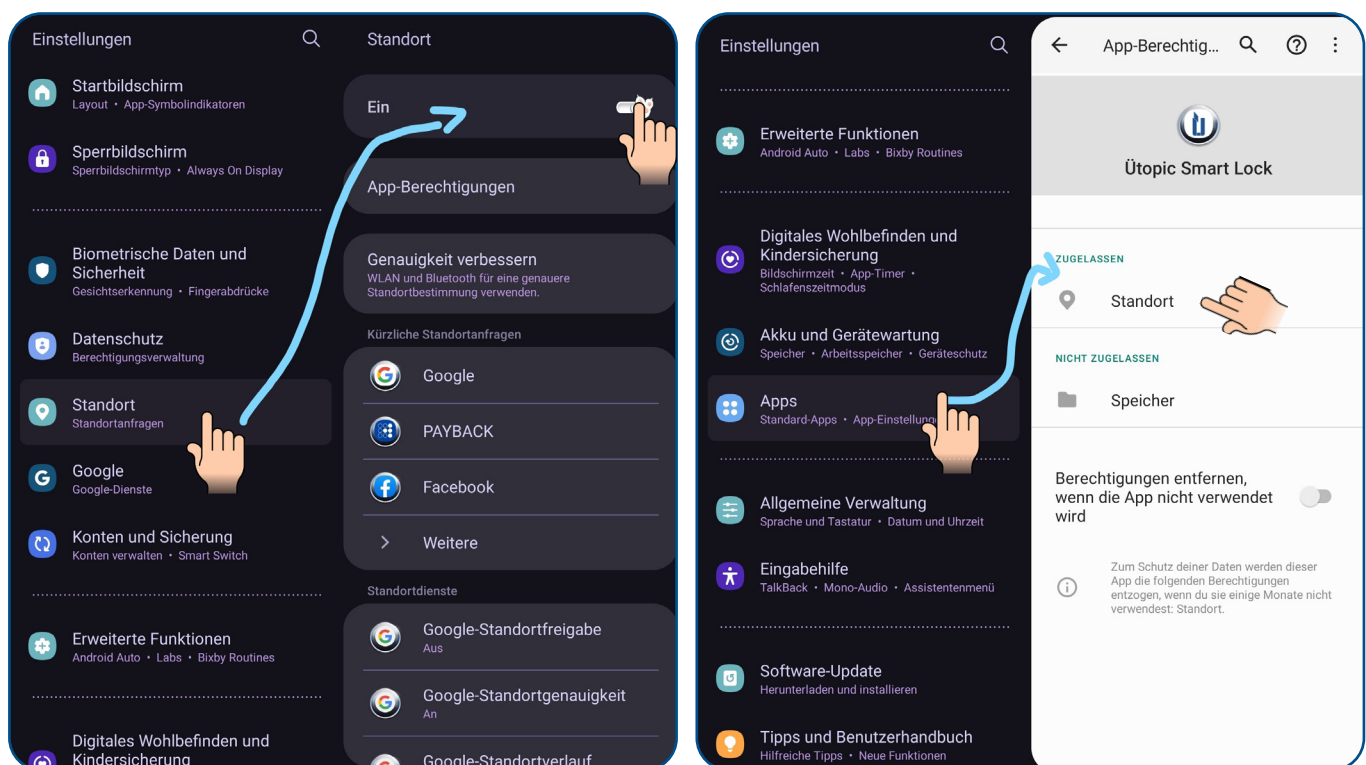

Due to the manufacturer and to different operating systems, there may be deviations in the display!

4.5 STARTUP VIA APP

- Open the ÜTopic app on your smartphone
- Connect the ÜTopic with the downloaded app using bluetooth (please note that you need to be near the door to do this and if you are the first one to log in, you will automatically be appointed admin)
- Select the language and choose a password
- Press and hold two buttons on the smartlock until you hear a long warning tone
- Then release the keys until you hear a short warning tone
- On the application screen, touch the „+“ in the upper left corner to see the list of the ÜTopic smartlock
- Touch the line ÜTopic , enter a name for your device and touch the „green tick“

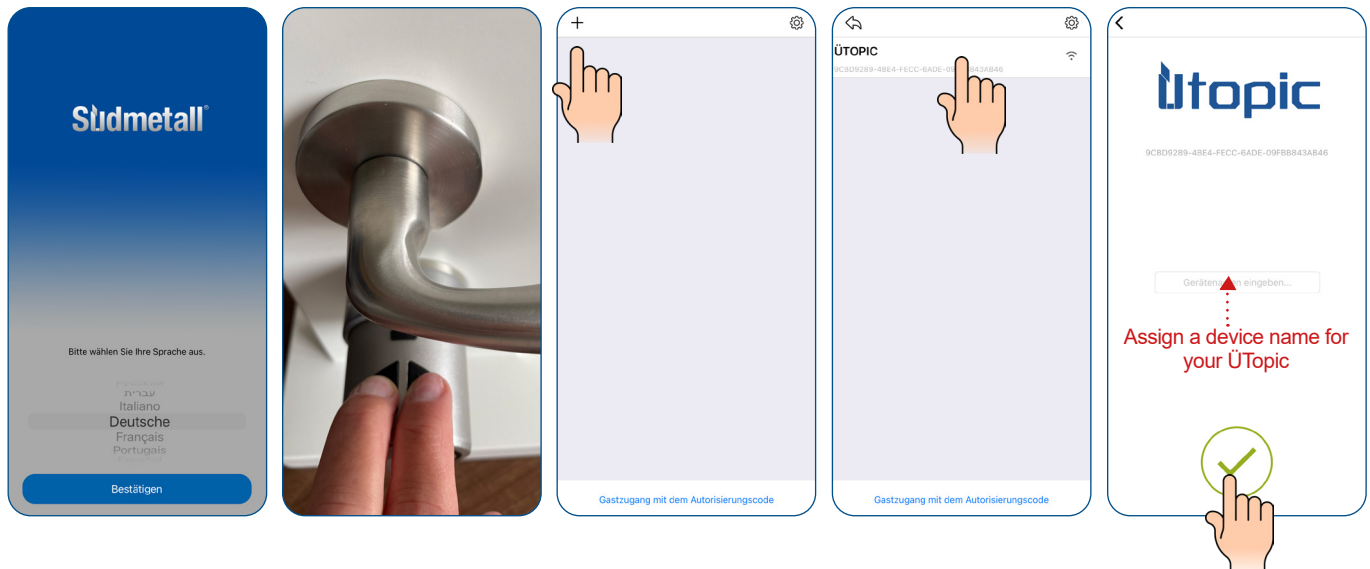

- As soon as the battery indicator appears in the menu you can start the setup wizard by clicking on the 3 horizontal lines in the upper right corner and select the knob settings item below
- Now select setup wizard

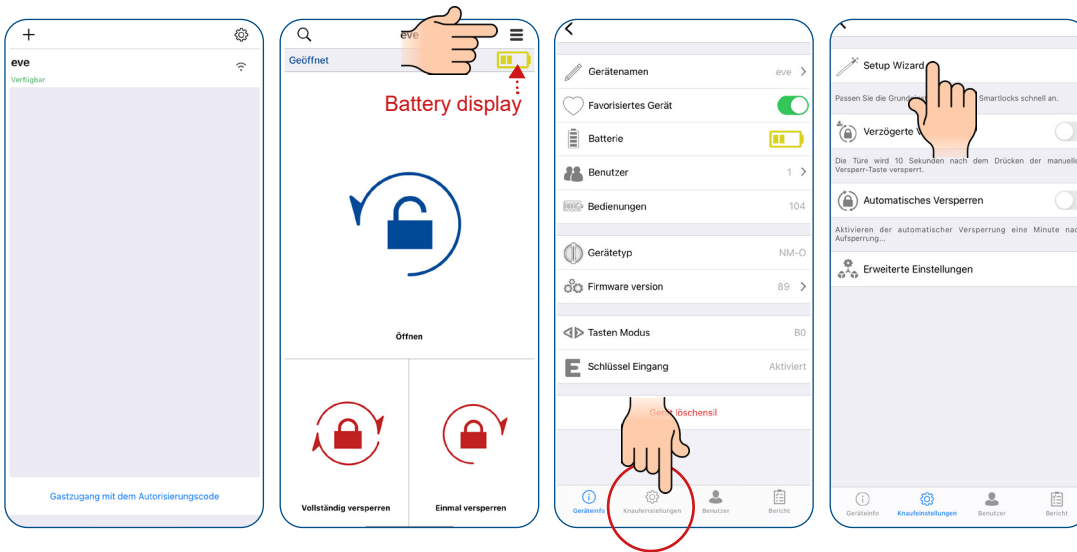

- Before using your smartlock, you need to set it correctly and adjust it to the appropriate door (lock type & number of turns). Just follow the instructions down below

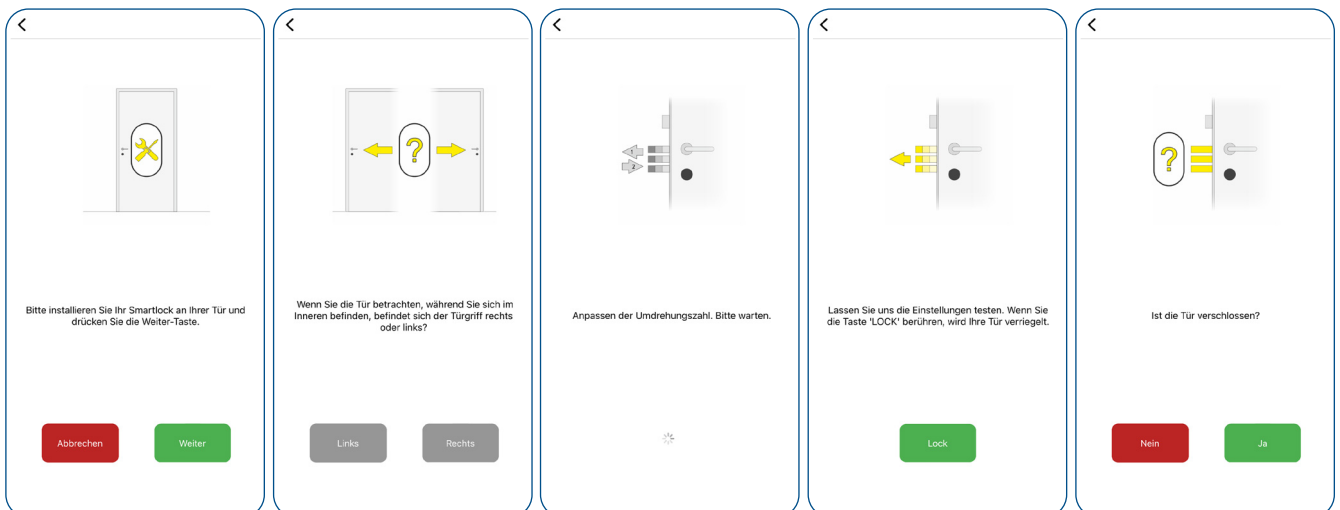

Screen 1: Ist die Tür verschlossen?
Buttons: Nein, Ja

Screen 2: Stecken Sie den Schlüssel von aussen ein. Dabei den Knopf leicht nach rechts und links drehen. Nach dem Einstecken des Schlüssels ganz einschliessen, drehen Sie den Schlüssel eine Vierteldrehung nach rechts oder links (etwa 90 Grad).
Button: Weiter

Screen 3: Entfernen Sie den Schlüssel. Drehen Sie den Daumen leicht nach rechts und links, um ihn wieder drehbar zu machen.
Button: Weiter

Screen 4: Das Gerät testet.
Icon: * (star)

Screen 5: Ist der Sperrvorgang erfolgreich?
Buttons: Nein, Ja

Screen 6: Versuchen Sie nun, den Schlüssel von außen einzuführen und zu drehen. Sie müssten diesen Vorgang ein wenig erzwingen. Ist der Schlüssel eingesteckt und drehbar?
Buttons: Nein, Ja

Screen 7: Entfernen Sie den Schlüssel. Drehen Sie den Daumen leicht nach rechts und links, um ihn wieder drehbar zu machen.
Button: Weiter

Screen 8: Die schnelle Einrichtung ist abgeschlossen. Sie können Ihren Smartlock verwenden.
Icon: ✓ (checkmark)

ATTENTION:
If your locking cylinder is equipped with an emergency and danger function, these setup steps are not required!



4.6 GENERAL APP SETTINGS (menu >>> device info)

You have already made the basic settings using the Set up Wizard.

The following is an overview of the other settings:

If the app is **not yet connected to the ÜTopic** and you touch the **menu button** in the upper right corner, you will get to the settings menu of the application. The related menu items are as follows:

- **PASSWORD:** You can disable, enable or change the password of the application. In addition you can enable biometric login or facial recognition in this menu
- **LANGUAGES:** You can change the language of the application
- **APPLICATION INFO:** You can see the version of the installed application
- **VIDEOS:** You can watch videos on the application of the ÜTopic from the manufacturer
- **FAQ:** You can view questions and answers about the use
- **SIRI-SETTINGS:** You can open your lock with voice commands (only for iPhone)

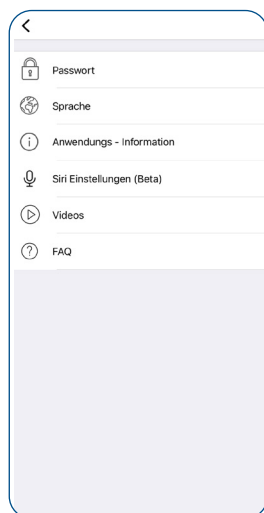

When the app is connected to the ÜTopic and you touch the menu button in the upper right corner, you will enter the settings menu of the connected ÜTopic. From this menu you can change the settings and perform administrative activities:

- **DEVICE NAME**
- **FAVORITE DEVICE**
- **BATTERY LEVEL**
- **USERS** (number of names and type of registered users)
- **OPERATIONS** (number of locks or unlocks)

- **DEVICE TYPE**
- **SOFTWARE VERSION**
- **KEY MODE**
- **ENCODER OR KEY INPUT**

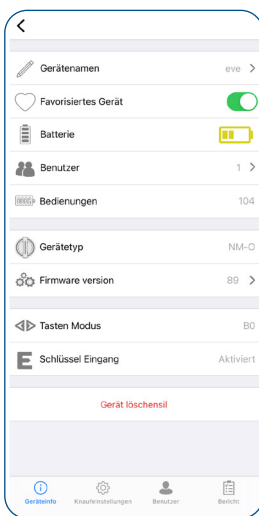

4.7 DELAYED LOCKING VIA APP (menu >>> knob settings)

- This setting can be found in the menu under knob settings >>> delayed locking
- If this function is activated, the device locks the door after 10 seconds after the lock button on the device is pressed

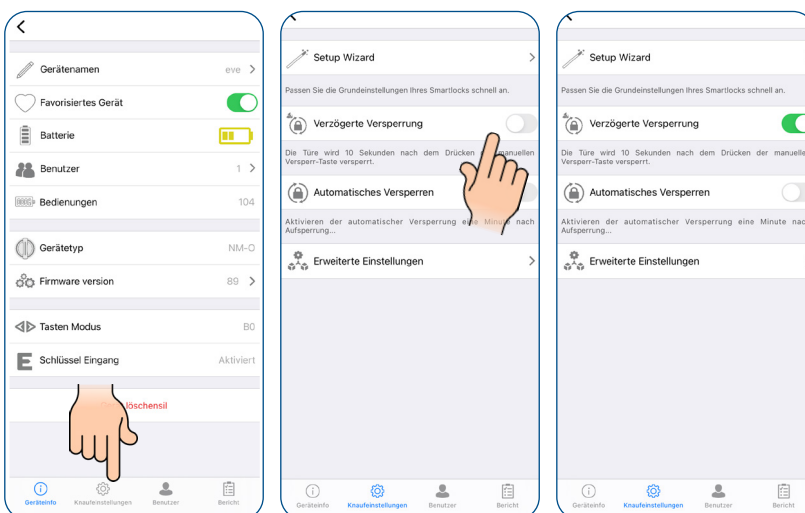

ATTENTION!

After activating the delayed locking function, please unpair once. Close the ÜTopic app, open it again and pair it again. After the app has reconnected with the ÜTopic, the changes have been applied correctly!

4.8 AUTOMATIC LOCKING VIA APP (menu >>> knob settings)

- This setting can be found in the menu under knob settings >>> automatic locking
- Your device has an auto-lock feature that allows the device to lock automatically (either one turn or two turns) 15, 30, 45, or 60 seconds after it is unlocked
- Under „day mode“ you can define yourself when the automatic locking is set: for example in companies which are automatically locked after the office closing time. Here are 2 different intervals possible

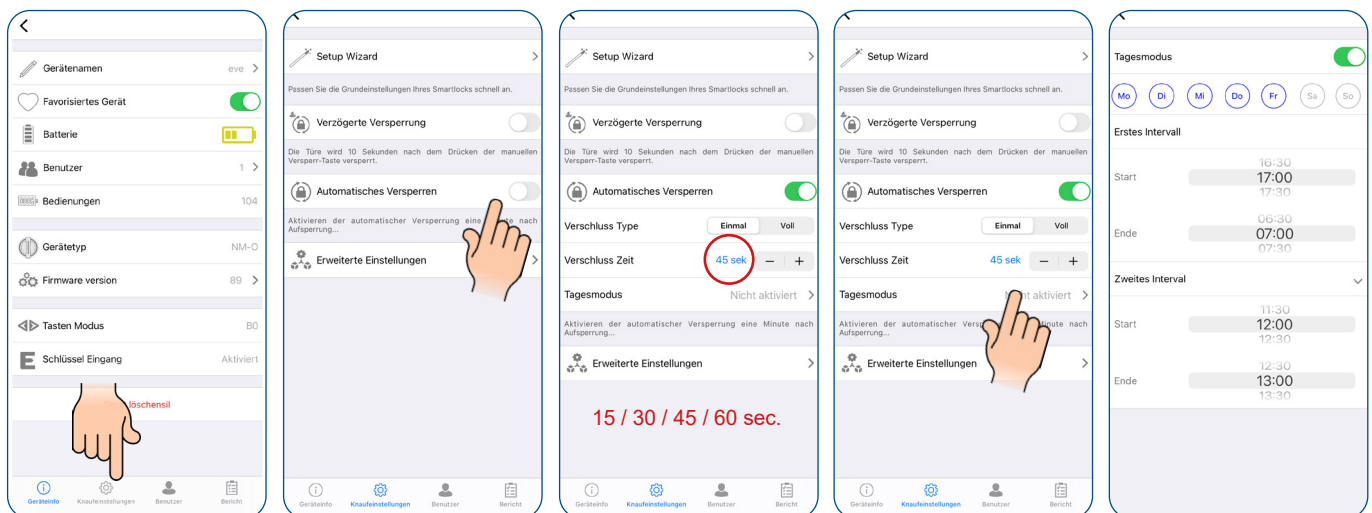

ATTENTION! After activating the automatic locking function, please unpair once. Close the ÜTopic app, open it again and pair it again. After the app has reconnected with the ÜTopic, the changes have been applied correctly!

4.9 ADVANCED APP SETTINGS (menu >>> knob settings >>> advanced app settings)

- This setting can be found in the menu under knob settings >>> advanced settings
- **Activation sounds** of the ÜTopic (buzzer of the knob) can be activated or deactivated
- **Reverse locking type:** You should set the locking type of the device in accordance with the locking direction of your door (if something went wrong here during the set up wizard, you can fix it under this menu item)
- **Defining the key overwrite position:** if profile cylinders are used without emergency and danger function

- **Time period of latch retraction:** you can set the time period in which the latch is retained when unlocked (1, 3 or 6 sec). 0 sec is for doors without latching
- **Motor power:** you can adjust the power and speed of the motor in 4 different levels. Use the lowest level that can lock and unlock your door without problems to promote long battery life
- **Key functions:** in this menu you can change the functions of the buttons:
 B0 - both keys work without restrictions
 B1 - both keys are activated (locking + unlocking possible), only the reset function is deactivated
 B2 - keys are deactivated
- **Child lock mode (night mode):** when you activate the child lock mode, the smart lock behaves like a normal mechanical lock. You can use it either with a mechanical key or with the handle only. None of the registered controllers (except master controller) and buttons on the smart lock will work until the child lock is deactivated. Neither the keyboard nor the remote control work. Only the admin can open the door with the app. To activate the child lock, press and hold two buttons on the smart lock until you hear a long (3 sec.) warning tone. To deactivate the child lock, press and hold two buttons on the smart lock until you hear 3 short warning tones
- **High quality HF connection:** you should activate this mode only if you have problems with the wireless keypad, fingerprint reader with integrated keypad, remote control or similar HF controlled control devices. For example, if your lock only works when you have to enter your password 2-3 times or use your finder several times, this mode should be enabled. If you do not have such a problem and enable this mode, your smartlock will consume more battery

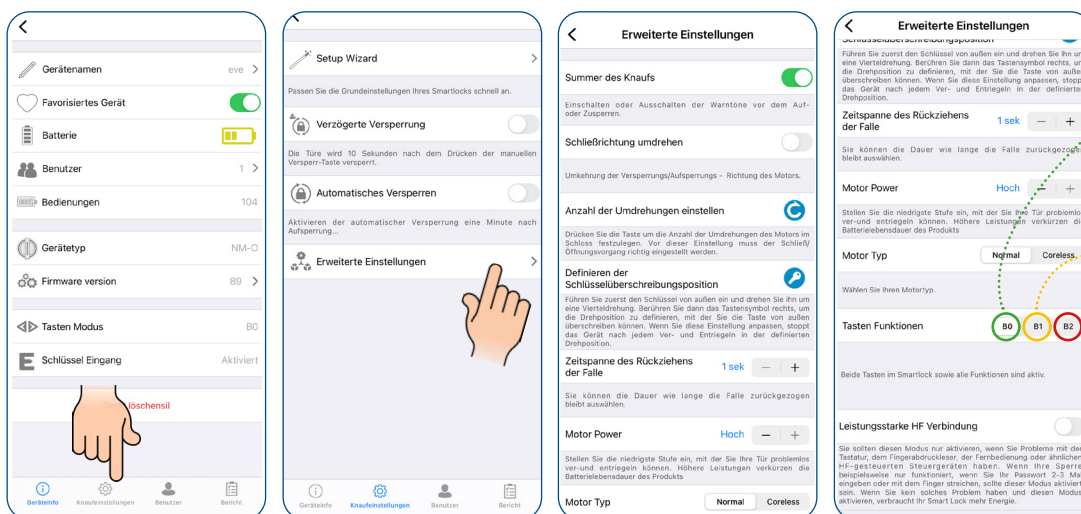

both keys work without restrictions

both keys are activated (locking + unlocking possible), only the reset function is deactivated

keys are deactivated (also applies as a child lock function!)

ATTENTION! After activating advanced settings for locking, please unpair once. Close the ÜTopic app, open it again and pair it again. After the app has reconnected to the ÜTopic, the changes have been applied correctly!

4.10 USER SETTINGS (menu >>> user)

- Here you can manage all users as admin as well as the compatible accessories (fingerprint, remote control); also create unique codes and passwords
- **USERS:** here you get an overview of the users
- **ADD NEW USER UNIT:** you can add and manage new users as well as compatible accessories (fingerprint reader with integrated keypad, wireless keypad or remote control) (up to 39 devices possible)
- **CREATE UNIQUE CODE:** here you can create unique, limited codes and send them via mail, WhatsApp,... to the authorized person
- **ONE TIME PASSWORD** (only compatible with keypad!): here you can generate unique, limited passwords, which will be entered into the keypad
- **DELETE ALL CONTROL UNITS:** here you can delete all previously registered users or accessories. Please note that you can delete the admin only after a new setup of the factory settings
- After a change in a setting, it is recommended to return to the main screen and press the lock or unlock button

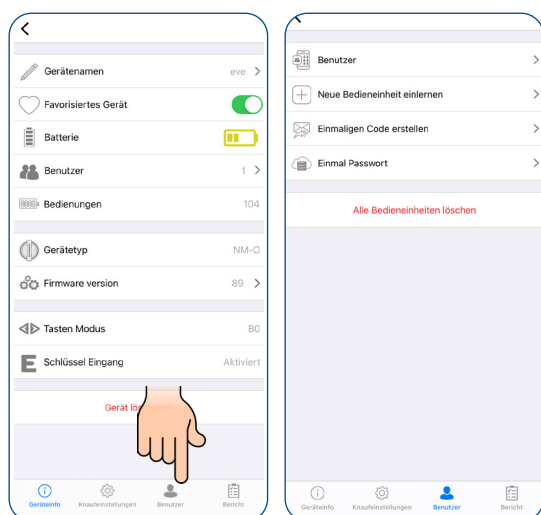

4.11 ADDING ANOTHER PERMANENT USER

- The other user must download the app from the respective app store (Android or IOS) using the QR code and select the language

- The administrator and the new user must be in the immediate area of the smartlock
- The administrator clicks on „teach new operating unit“, then click on the green +
- The smartlock makes a long, then a short warning tone
- The admin's app jumps to the initial position. Important: the admin may only execute further commands once the new user has connected to the ÜTopic!

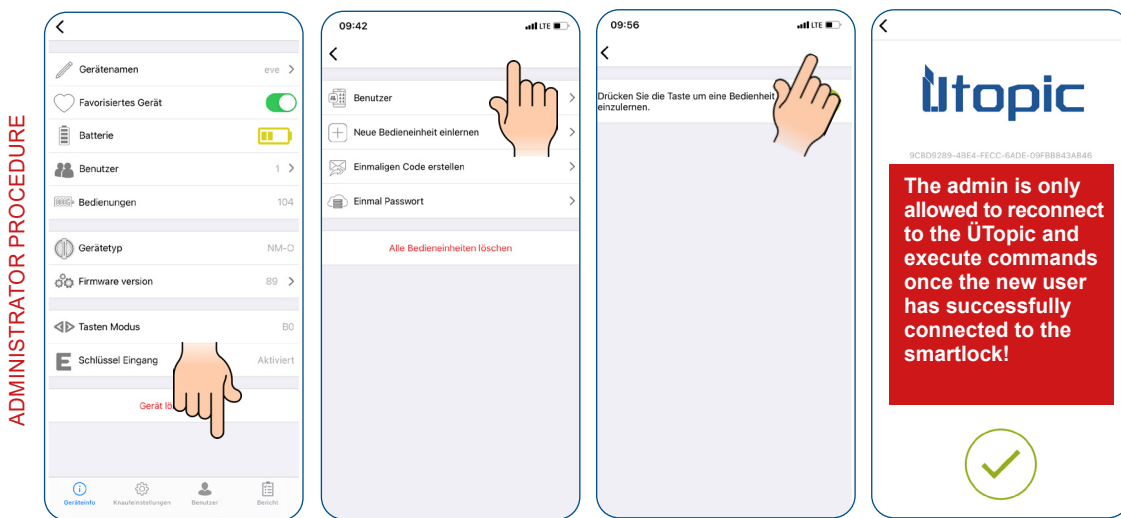

- The new user opens the app and then clicks on the + in the upper left corner and gets a listing of the available ÜTopic
- The new user touches the ÜTopic line and assigns a device name (this does not have to be identical to the device name assigned by the administrator, even if it is the same ÜTopic)
- When you hear several warning sounds, the smartlock and the new smartphone are successfully paired

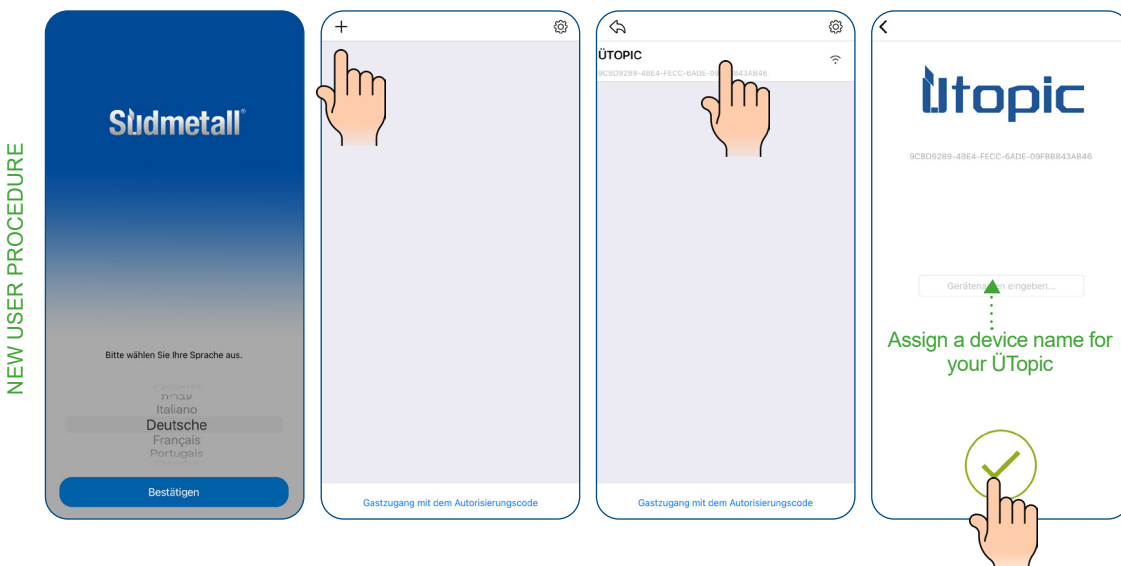

- After the new user has successfully logged in, the administrator can still define the time limit for the new user. To activate this just click on the corresponding user
- Then activate time limited access and define time span, weekdays and times

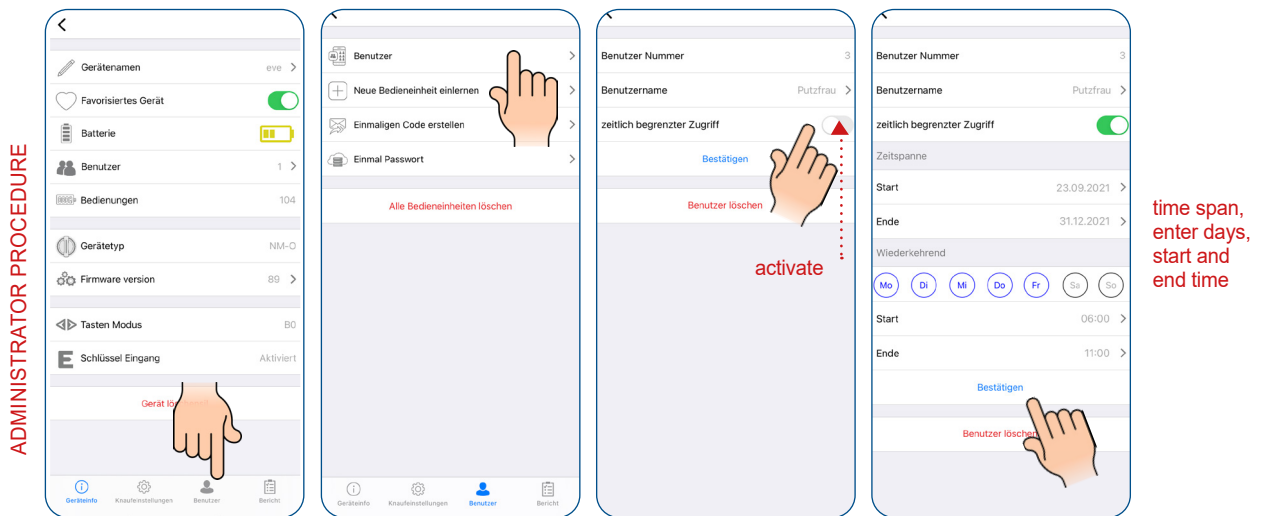

4.12 UNLOCKING THE DOOR VIA GENERATED CODE (menu >>> user)

ADMINISTRATOR

- Click on „create one-time code“ in the menu under the item users
- „Time limited access“ allows the code to be valid in the period you define (for example, when renting a vacation home). Enter start and end date
- By clicking on „create unique code“ you will receive the access code, which you can share via mail, WhatsApp...

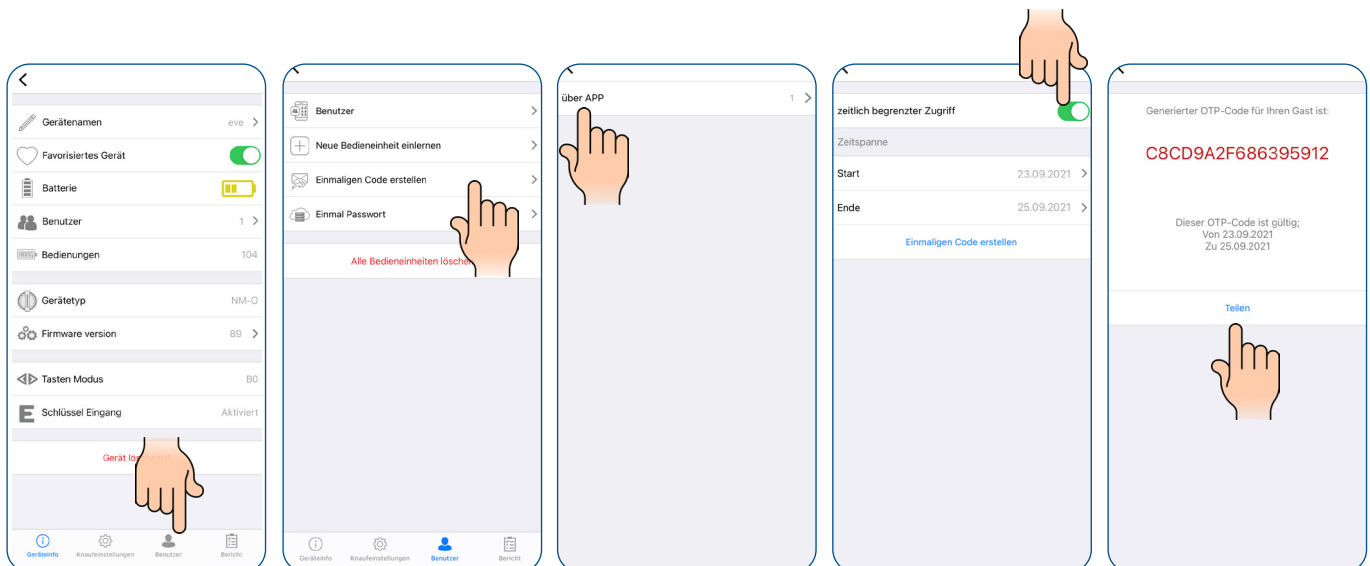

GUEST

- Copy the shared code to the clipboard. (You can copy the entire shared text. The app will delete the code automatically)
- Install the ÜTopic application on your smartphone, launch the app, select the language
- Hold your smartphone as close as possible to the door where the smartlock is installed and touch the „use one time pass code“ button located at the bottom of the main screen
- A pop-up window will open where you can enter the code. Touch the „close“ button. When you see the code as it is written on the screen, touch the „green tick“ to unlock the door
- If the code is valid for the lock, the smartlock will unlock the door and you will see a popup with a confirmation



4.13 PAIRING ÜTOPIC WITH COMPATIBLE ACCESSORIES

(menu >>> user >>> teach in new operating unit)

- The ÜTopic can be paired with up to 39 compatible controllers
- Tap on „teach in new operating unit“ and then on the green plus in the top right corner. A long and a short signal tone will sound

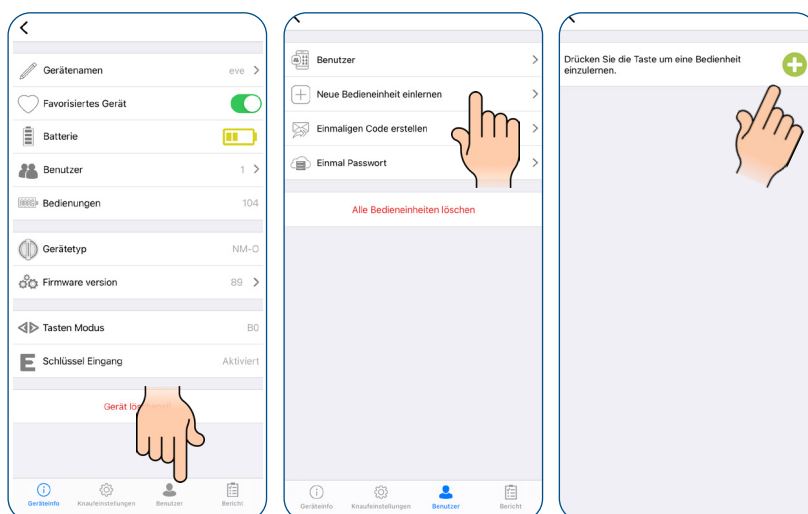

After the short signal tone, please follow the instructions below:

- Fingerprint reader with keypad / wireless keypad:** touch the device with your palm, tap the left button and then enter the 5-digit master password or touch the sensor with the master fingerprint
- Remote controller:** press and hold any button for several seconds
- Smarthome automation interface:** Turn on the device, short-circuit the yellow and black cables briefly and then open them



FINGERPRINTREADER WITH INTEGRATED KEYPAD / WIRELESS KEYPAD



REMOTE CONTROLLER



SMART HOME AUTOMATION

- The administrator can still define the time limit that they would like to give to the new user. To do this, the admin must call up the users and click on the corresponding user
- Afterwards activate the time limited access and define the time span, weekdays and times

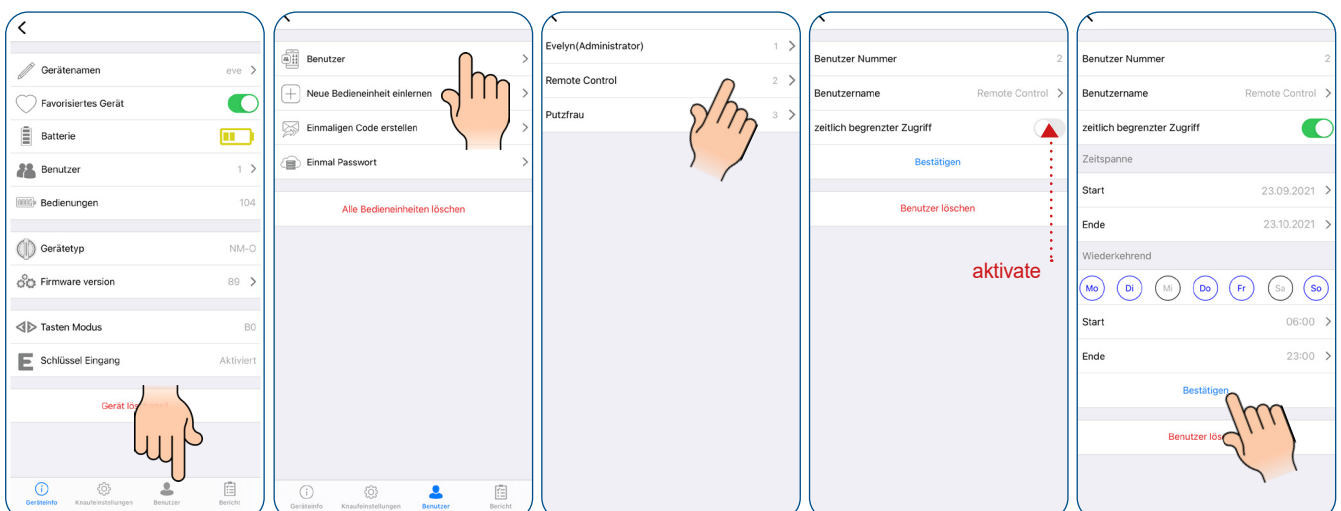

4.14 DELETE USER (menu >>> user)

Delete users easily under the menu item user.

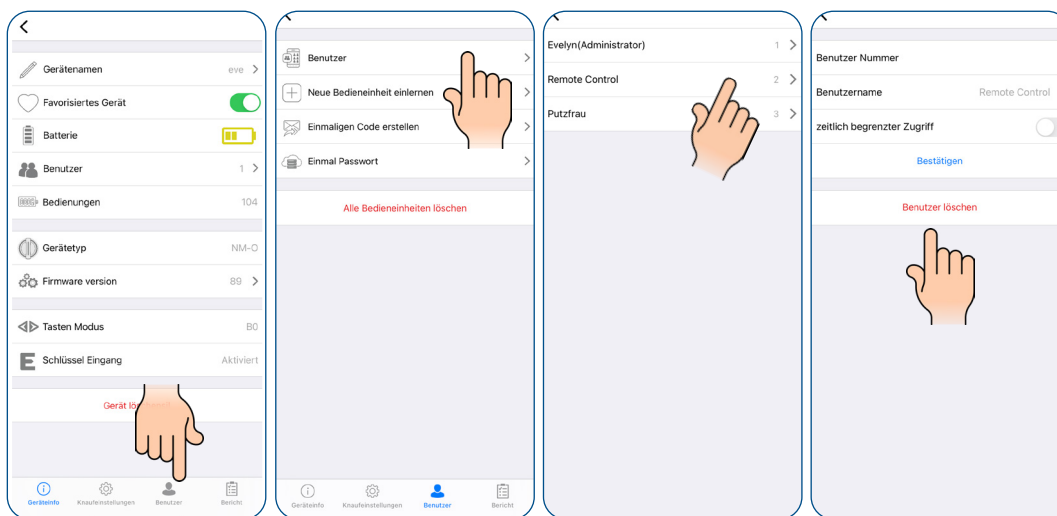

4.15 DELETE ADMINISTRATOR (menu >>> user)

If you want to delete the administrator of your smartlock, you must reset your smartlock as described below:

- Press and hold both buttons on the smartlock
- A long tone sounds; continue to press the buttons
- After a while you will hear a second warning tone: now let go of the buttons and quickly plug the charger into the USB charging port of the smartlock (charger should be connected to the power outlet)
- Once you hear a double and then a triple tone all logged in users, including administrator have been successfully deleted

4.16 REPORT (menu >>> report)

On this tab you can see which user has unlocked or locked the device with time and date information.

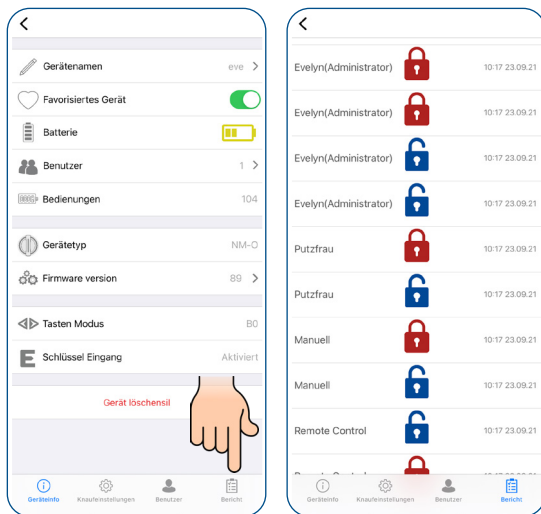

4.17 RECHARGE ÜTOPIC

- If you hear three short beeps after operating the ÜTopic or if the rotation speed slows down compared to the usual speed, the ÜTopic needs to be charged. The app also shows you the battery level of the ÜTopic
- The charging time of the device is approximately 3 hours. We recommend charging it under supervision every 60 to 90 days, even if the batteries are not empty
- Use the supplied charger and cable. At your own risk, you can use any or longer 5V DC micro USB charging cables or a powerbank. Use only high quality chargers, cables and powerbanks
- The ÜTopic works even if it is currently in charging mode. The device continues to lock your door even if it is currently charging
- If you leave your home for a long period of time, fully charge the device first and take your mechanical key with you. If you are leaving for more than 2 months, switch the ÜTopic to child lock after charging. Otherwise, the batteries of your product would become defective due to deep discharge

4.18 SOFTWAREUPDATE

1. Connect to the ÜTopic via the admin smartphone and touch the menu button
2. On the „device info“ tab, touch the „firmware version“ line
3. When a new software version is available, the application will notify you
4. Tap the „start“ button and follow the instructions of the application

Tip:

- Make sure that the charge level of the admin smartphone and the ÜTopic is at least 50% during the update process
- To avoid interruptions, it is recommended to switch the admin smartphone to flight mode before starting to update the software
- The update process takes about 10 minutes. Leave the smartphone near the ÜTopic during this time
- Make sure that the bluetooth connection is not going to be lost and the application is not going to be closed. If your smartphone has an automatic screen lock, always turn off this function during the update

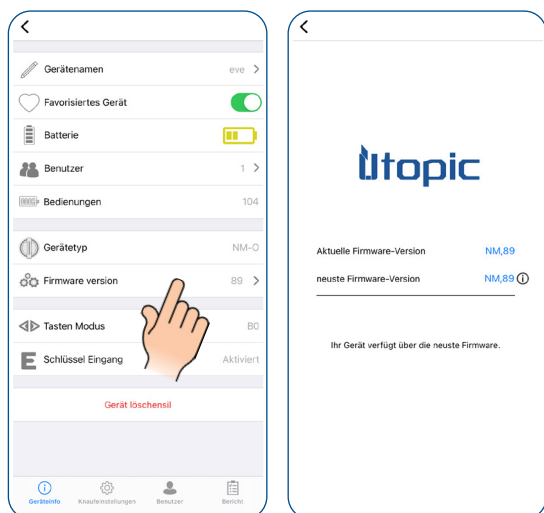

5. FAQ

ÜTopic cannot be completely locked or unlocked

There may be high friction on the lock or on the latch. The reason may be a sagging of the door or an unadjusted closing mechanism. Check if you can easily open the lock and latch with a key. If there is a problem with the door or lock, it must be fixed. Pay attention to the correct preparation of the key.

- The batteries of the ÜTopic may be weak. Recharge the batteries
- The ÜTopic must be set to the lock after installing the smartlock

The cylinder can't be locked or unlocked even though the ÜTopic is turning

Please make sure that the key head has been cut off correctly!

If there is a problem with the connection between motor and rotating shaft please contact us at +49 8654 4675 50.

Keys on the ÜTopic cannot be pressed

The child lock would be activated. To deactivate the child lock, press the two keys on the ÜTopic and wait until you hear 3 short warning tones.

Settings of the ÜTopic can't be changed with the smartphone

The smartphone is not signed in as admin for the ÜTopic. If you want to change the master controller of the ÜTopic, you must reset the device to factory settings.

Smartphone can't be defined as admin

- There is a user who is already logged into the smartlock. If you want to change the admin, you must reset the ÜTopic first and then register the desired smartphone
- If you reset the smartlock, all users, including the auto-locking-module, fingerprint reader, etc., must be re-created on the ÜTopic after the new admin is registered

Smartphone fails to connect to the device

- For Android smartphones, all permissions (for example, location, bluetooth, etc.) requested during the installation of the application must be granted without restrictions. If you didn't allow the app to reach the requested permissions, you need to uninstall the app, then reinstall it and allow the requested permissions during the installation process
- If you have this problem when logging your smartphone into the ÜTopic, you may have forgotten to put the ÜTopic into login mode

Keys of the ÜTopic do not work

- The smartlock is in child lock mode (night mode)
- The smartlock stops working due to a low battery. Charge the device with the supplied charger for 3 hours
- If the device is not used for a long period of time, the batteries may be damaged
- Check the key mode. If it is in B2 mode, you can't use the keys

Locking and unlocking keys work in the wrong direction

You must reverse the locking path in the settings.

Forgot password app

If you have forgotten your password, there is no way to get it back. As a solution, you need to delete the app and reinstall it. However, in this case, your smartphone won't recognize your ÜTopic. You need to reset your ÜTopic and put it in pairing mode.

I can't adjust the engine power

If your ÜTopic software version is below 80, you won't be able to change the motor power, although you will see this setting. To use this function, you must update your ÜTopic to the latest software.

Temporary or one-time access code cannot be created

If your ÜTopic software version is below 80, you won't be able to create a temporary access code via the application. To use this function, you must update your ÜTopic to the latest software.

Mechanical key can't be used on outside door

- The key input section on the device information screen should be active. If not, you will need to reset your ÜTopic and pair with admin. Software version 89 or higher has the ability to enable key entry mode through the app:
 - > Press the „enable key input“ button, disconnect the lock and wait 10 seconds. After these steps, you must be able to use the key from the outside.
- You may not have set the key override position. You can change the setting in the „advanced settings“ section

The control buttons do not work

It often happens that customers accidentally activate the child function by pressing the two control keys at the same time. As a result, the ÜLock will no longer respond to manual operation of the right or left key. To deactivate the child lock mode again, both control keys must be held down for several seconds at the same time.

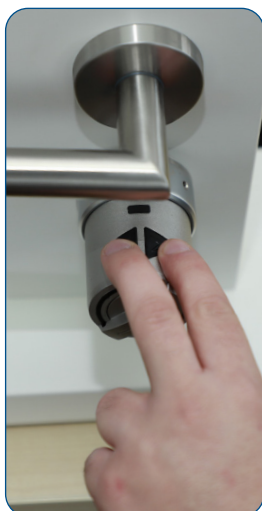

Press and hold both control keys simultaneously for several seconds: **child function is activated!**

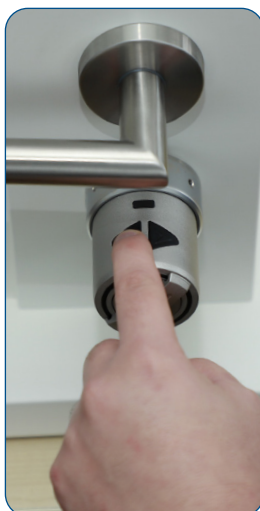

Due to the child lock function, the ÜTopic doesn't react, neither by pressing the left or the right button!

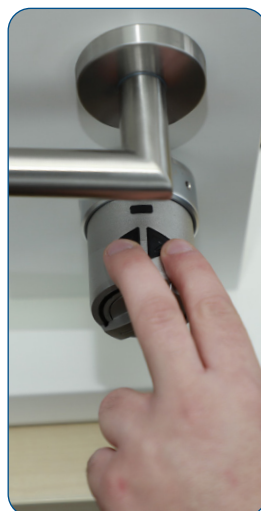

Press and hold both control keys simultaneously for several seconds: **child function is deactivated again!**

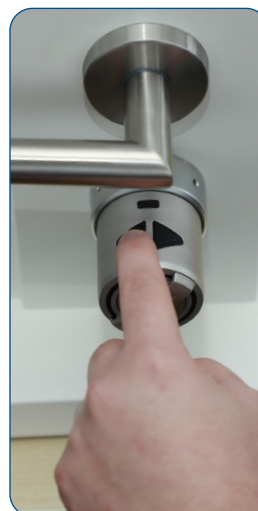

The ÜTopic now responds again, because the child lock has been deactivated!