

FLB - Breite von Flügelteil  
 FTB - Breite von Festteil  
 FLH - Höhe von Flügelteil (Blatt 3)  
 FTH - Höhe von Festteil (Blatt 3)

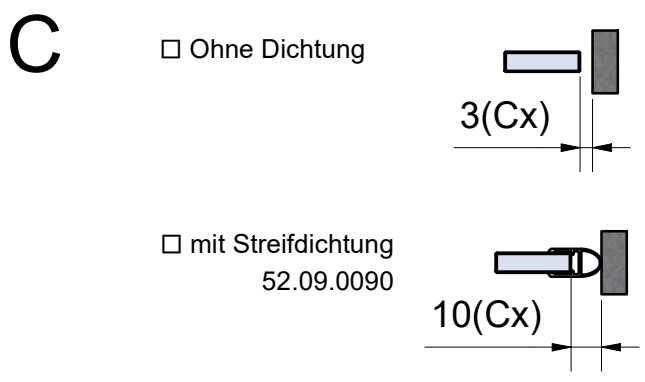

### Türdichtung unten (TDu)

Ohne Dichtung

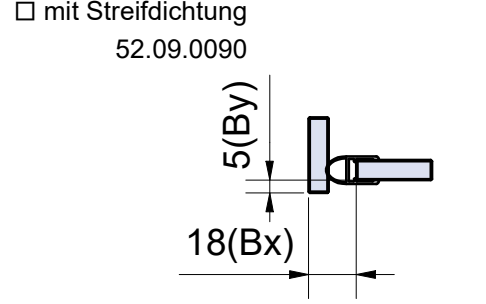
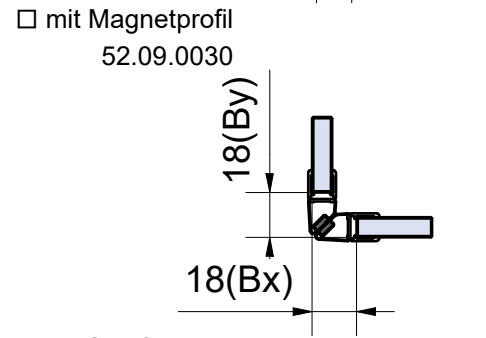
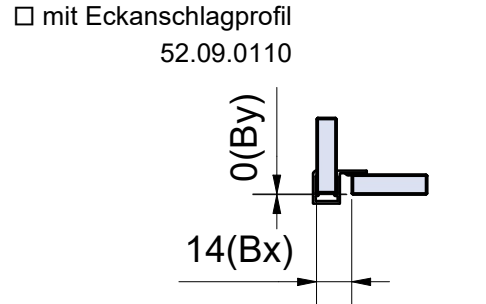
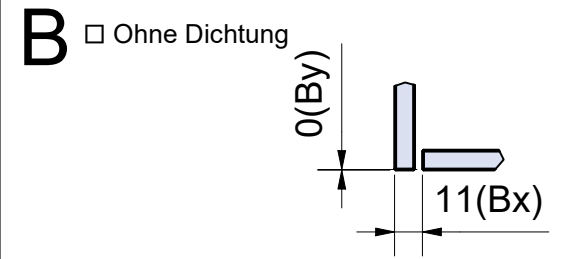
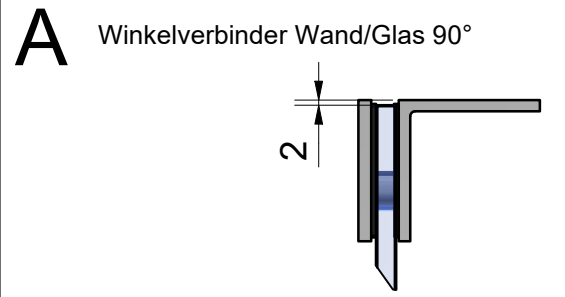
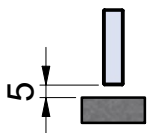

mit Streifdichtung  
52.09.0190

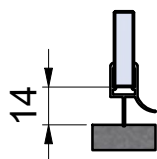

mit Streifdichtung  
52.09.0260

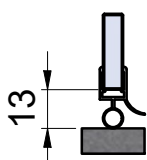

mit Streifdichtung und Alu-Schwallschutzprofil 52.05.0010

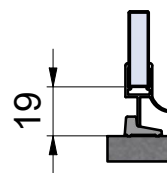

mit Streifdichtung und PVC-Schwallschutzprofil

52.05.0210

52.05.0220

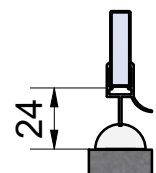
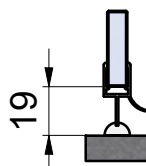

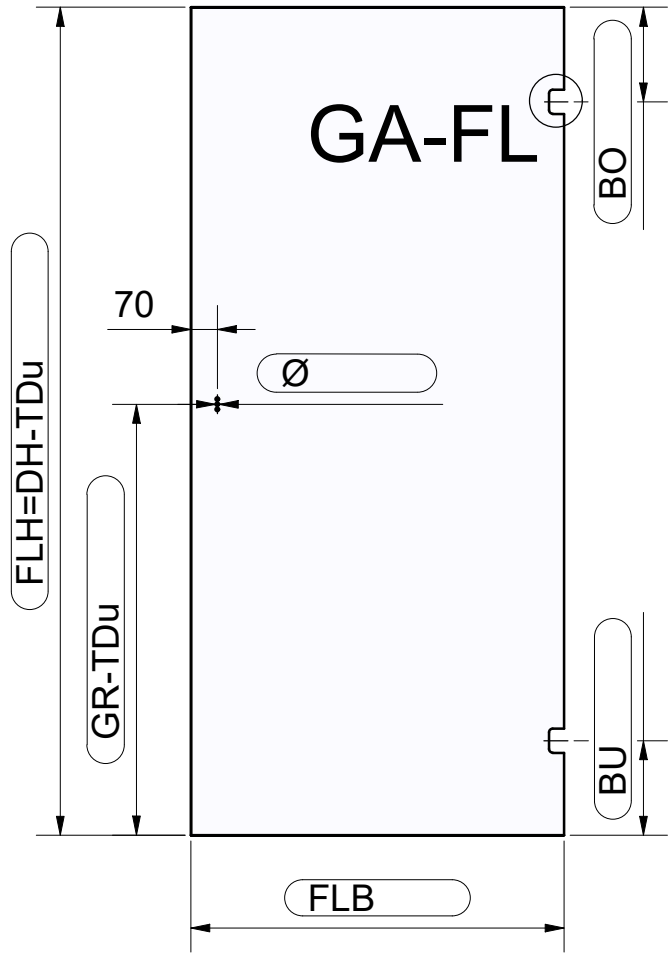
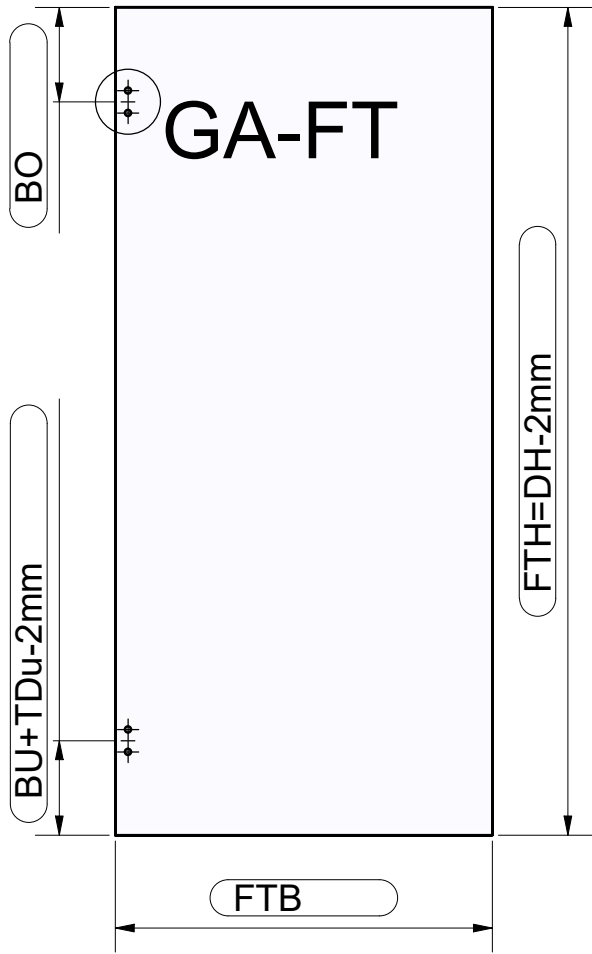

**GA-FT** (Glasausschnitt Festteil)

**GA-FL** (Glasausschnitt Flügelteil)

Ohne Dichtung

mit Streifendichtung  
52.09.0090

